



Technical Information

C45-SATA

SATA/USB

Low Cost 4HP Mezzanine Storage Module

Document No. 5535 • Ed. 7 • 17 October 2011



Contents

| | |
|--|----|
| About this Manual | 3 |
| Edition History | 3 |
| Related Documents | 4 |
| Nomenclature | 4 |
| Trade Marks | 4 |
| Legal Disclaimer - Liability Exclusion | 4 |
| Standards | 5 |
| Feature Summary | 6 |
| Short Description | 7 |
| Block Diagram | 8 |
| Top View Component Assembly | 9 |
| Front Panel | 12 |
| Installing and Replacing Components | 13 |
| Before You Begin | 13 |
| Warnings | 13 |
| Caution | 13 |
| Installing the Board Assembly | 14 |
| Removing the Board Assembly | 15 |
| EMC Recommendations | 16 |
| Technical Reference - Connectors | 17 |
| Caution | 17 |
| Please Note | 17 |
| I/O Connectors | 18 |
| P-SATA1A/B Micro SATA Docking Header | 19 |
| SATA-2 SATA-3 eSATA F/P Connectors | 21 |
| USB F/P Receptacles | 22 |
| Inter-Board Connector | 23 |
| P-MEZ | 24 |
| Schematics | 27 |

About this Manual

This manual is a short form description of the technical aspects of the C45-SATA, required for installation and system integration. It is intended for the advanced user only.

Edition History

| EKF Document | Ed. | Contents/Changes | Author | Date |
|----------------------------|-----|--|--------|--------------------|
| Text # 5535 c45_tie.wpd | 1 | Technical Information C45-SATA English, Preliminary Edition | jj | 20 April 2009 |
| | 2 | Updated illustrations | jj | 19 May 2009 |
| | 3 | Incorporates removable SSD version | jj | 16 June 2009 |
| | 4 | Updated illustrations and SSD connector designations | jj | 2 July 2009 |
| | 5 | Added photos | jj | 8 March 2010 |
| | 6 | Added photos PC1-GROOVE with C45-SATA | jj | 28 May 2010 |
| | 7 | Added link C45-SATA homepage | jj | 17 October 2011 |



C45-SATA (Removable SSD) • PC1-GROOVE

Related Documents

| Related Documents CPU Cards | |
|-----------------------------|--|
| CCM-BOOGIE | www.ekf.com/c/ccpu/ccm/ccm_e.html |
| PC1-GROOVE | www.ekf.com/p/pc1/pc1.html |
| SC1-ALLEGRO | www.ekf.com/s/sc1/sc1.html |

| Related Documents Mezzanine Modules and Side Cards | |
|--|--|
| C45-SATA Home | www.ekf.com/c/ccpu/c45/c45.html |
| C40 ... C45 Series Mezzanine Storage Modules | www.ekf.com/c/ccpu/c4x_mezz_ovw.pdf |
| Mezzanine Modules Overview | www.ekf.com/c/ccpu/mezz_ovw.pdf |
| The EKF Mezzanine Module Concept | www.ekf.com/c/ccpu/cpci_mezzanine_evolution.pdf |

Nomenclature

Signal names used herein with an attached '#' designate active low lines.

Trade Marks

Some terms used herein are property of their respective owners, e.g.

- ▶ Intel, Pentium, Celeron, Core 2 Duo, Core i7: ® Intel
- ▶ CompactPCI, CompactPCI PlusIO, CompactPCI Serial: ® PICMG
- ▶ Windows XP, WEPOS, POSReady, Windows 7: ® Microsoft
- ▶ EKF, ekf system: ® EKF

EKF does not claim this list to be complete.

Legal Disclaimer - Liability Exclusion

This document has been edited as carefully as possible. We apologize for any potential mistake. Information provided herein is designated exclusively to the proficient user (system integrator, engineer). EKF can accept no responsibility for any damage caused by the use of this manual.

Standards

| Specifications/Standards | |
|--------------------------|--|
| SATA | Serial ATA 2.5/2.6 Specification (www.sata-io.org) |
| SFF | SFF-8144 Specification for 54mm x 78.5mm Form Factor with micro SATA connector (ftp://ftp.seagate.com/sff/) |
| USB | Universal Serial Bus Revision 2.0 specification (www.usb.org/developers) |



C45-SATA (Fixed SSD) • CCM-BOOGIE

Feature Summary

| Feature Summary | |
|--|--|
| Form Factor | <ul style="list-style-type: none"> ▶ Proprietary size mezzanine module 97mm x 100mm ▶ 4HP (20.32mm) mounting offset with respect to the CPU carrier board ▶ Typically delivered as a ready to use assembly unit (including the CCM-BOOGIE or successor CPU card) ▶ Mounting position right (on top of CPU board) ▶ 8HP front panel width (with front I/O connectors) |
| Host I/F Connector (Bottom Mount to CPU Carrier) | <ul style="list-style-type: none"> ▶ P-MEZ High Speed mezzanine connector suitable for CCM-BOOGIE and successor CPU carrier boards ▶ Nominal headroom 18.7mm (4HP) between carrier board and C45-SATA ▶ 3 x SATA channels (2 RAID capable) ▶ 4 x USB ports (3 in use only) |
| SATA Usage | <ul style="list-style-type: none"> ▶ P-SATA1A: horizontal mount docking connector (from ICH southbridge on CPU carrier board), suitable for on-board 1.8-inch Micro SATA SSD, dimensions according to SFF-8144 (54mm x 78.5mm x 5mm), for internal SSD ▶ Alternate vertical mount docking connector P-SATA1B, for removable SSD through front panel cutout (not together with P-SATA2 and P-SATA3 available) ▶ P-SATA2 and P-SATA3: front panel eSATA connectors (derived from the CPU carrier board secondary SATA controller), suitable for SATA RAID level 0/1 or non-RAID applications with external e-SATA device(s) |
| USB Usage | <ul style="list-style-type: none"> ▶ Up to 3 x USB type A receptacles, front panel I/O ▶ Overcurrent protection (electronic switches) |
| On-Board Storage | <ul style="list-style-type: none"> ▶ 1.8-Inch SATA Solid State Drive (SSD) on-board drive option ▶ Device provided by EKF or customer ▶ Intel X-18M Multi Level Cell (MLC) recommended |
| Thermal ¹ Conditions | <ul style="list-style-type: none"> ▶ Operating temperature: 0°C ... +70°C ▶ Storage temperature: -40°C ... +85°C, max. gradient 5°C/min ▶ Humidity 5% ... 95% RH non condensing |
| Environmental ¹ Conditions | <ul style="list-style-type: none"> ▶ Altitude -300m ... +3000m ▶ Shock 15g 0.33ms, 6g 6ms ▶ Vibration 1g 5-2000Hz |
| EC Regulations | <ul style="list-style-type: none"> ▶ EN55022, EN55024, EN60950-1 (UL60950-1/IEC60950-1) ▶ 2002/95/EC (RoHS) |
| MTBF | tbd |

¹ Observe degradation of temperature limits and other conditions when hard disk drive is in use in place of SSD - consult manufacturers data sheet - SSD recommended for rugged environment

Not all of the connectors may be present or functional on your actual C45-SATA board; assembly is highly custom specific. Options may be exclusive, i.e. not necessarily concurrently present. Discuss your needs with EKF before ordering.

Short Description

Available as a mezzanine add-on expansion board to the CCM-BOOGIE, PC1-GROOVE and successor CPU carrier cards, the main purpose of the C45-SATA is to provide SATA and USB connectors for front panel I/O. In addition, the C45-SATA can accommodate a 1.8-inch SATA SSD (Solid State Drive). Since only a few active components are required on the C45-SATA PCB, it is a reasonable low cost system expansion module.

Two eSATA connectors are available via the C45-SATA front panel, for attachment of external drives via eSATA cable harnesses. The SATA channels may be either operated in a low level RAID (0/1) mode, or as universal non-RAID SATA ports, driven by the CPU carrier board SATA controller.

In addition, three USB 2.0 receptacles are situated in the front panel, for universal use. All connectors are individually protected from an overcurrent situation by electronic switches.

The C45-SATA accommodates a 1.8-inch SATA drive, attached to the Micro SATA docking header (ICH/PCH Southbridge bound). A solid state drive (SSD aka Flash Drive) according to SFF-8144 (54mm x 78.5mm x 5mm) is recommended for fast and rugged operation.

As an alternate, a modified C45-SATA version is available which allows to remove/insert the solid state drive through the front panel.

The C45-SATA mounts on top of the CPU carrier board, with a 4HP pitch off-stand, resulting in a 8HP front panel for the entire dual-board assembly. If no front panel I/O would be required (I/O connectors not populated), a 6HP common front panel would be also suitable (5mm mounting height SATA SSD assumed). For low cost applications, the C45-SATA can be populated with either the internal Micro SATA connector only (pure storage module function), or the front panel connectors only (pure I/O expansion module).



C45-SATA (Removable SSD) • CCM-BOOGIE

Block Diagram

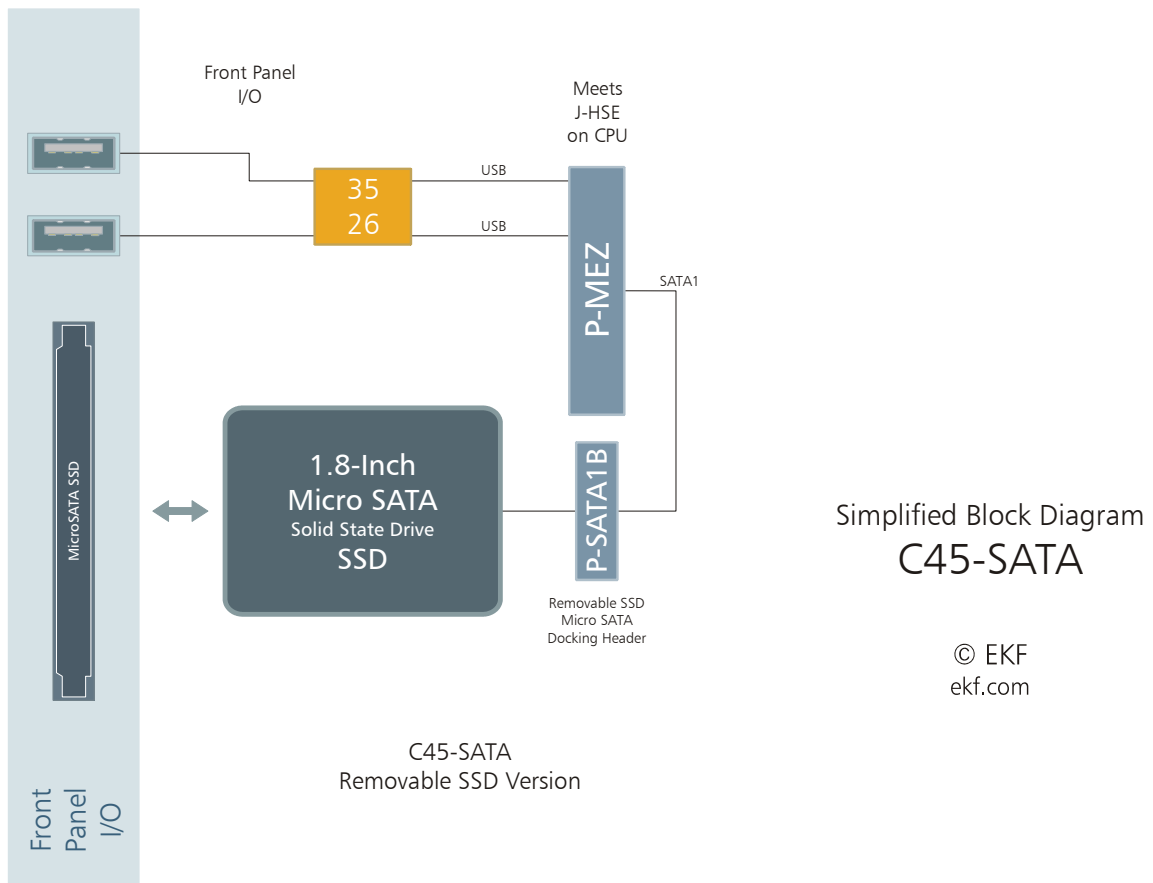
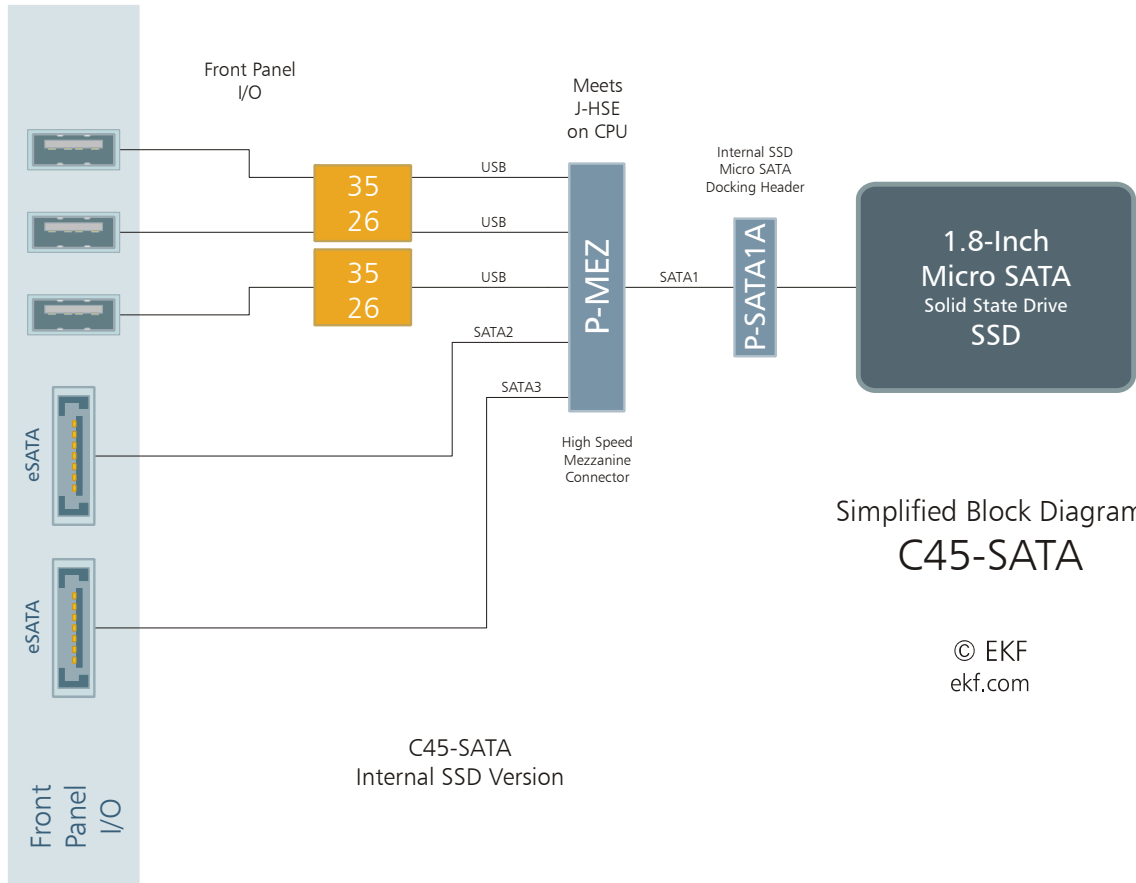

Top View Component Assembly

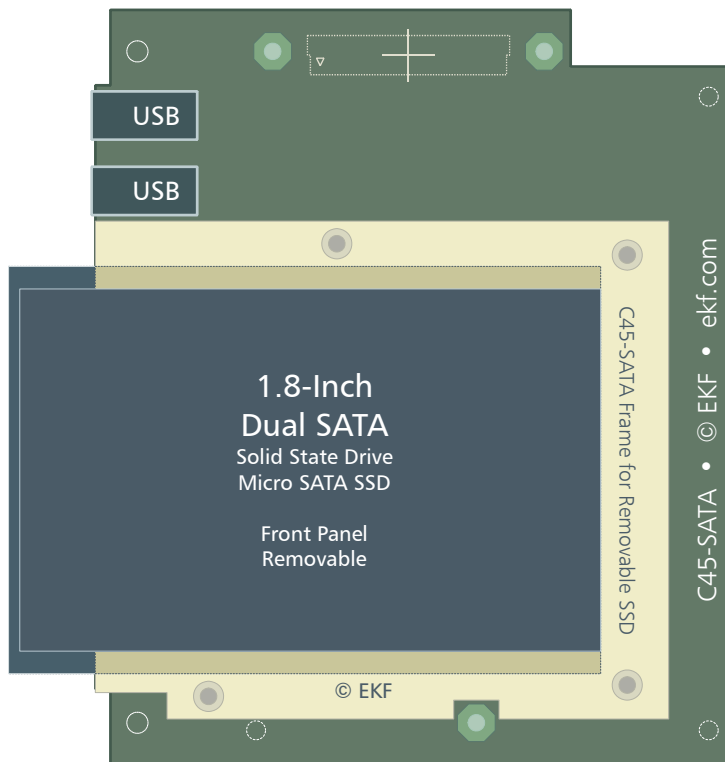
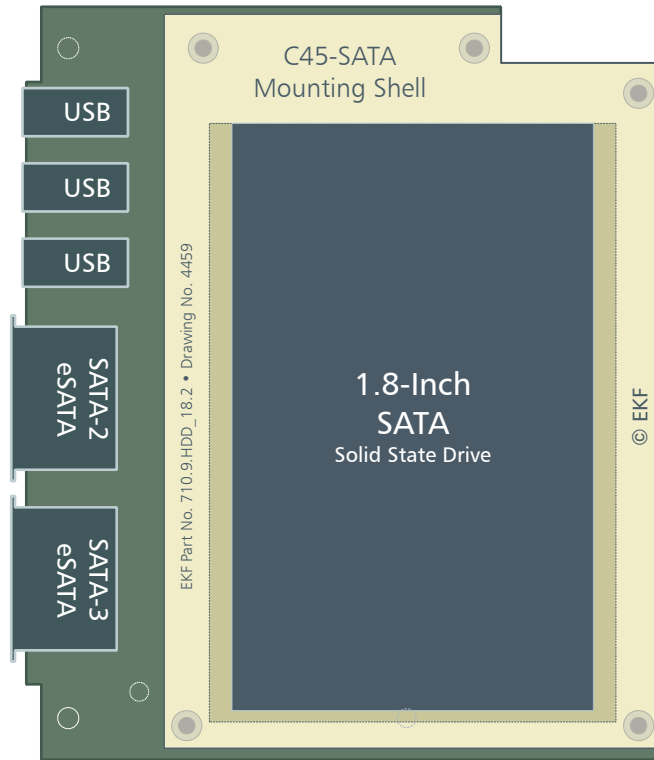

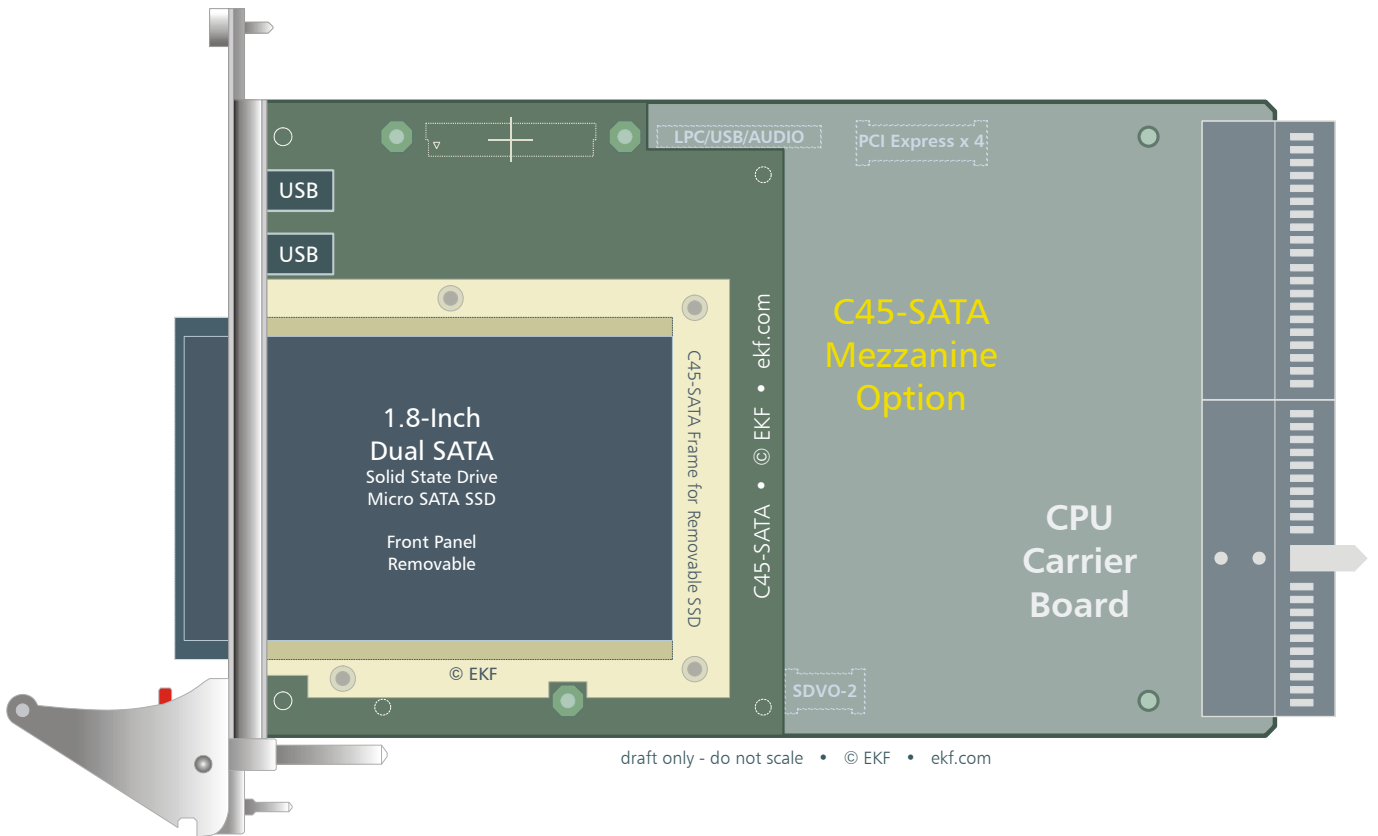
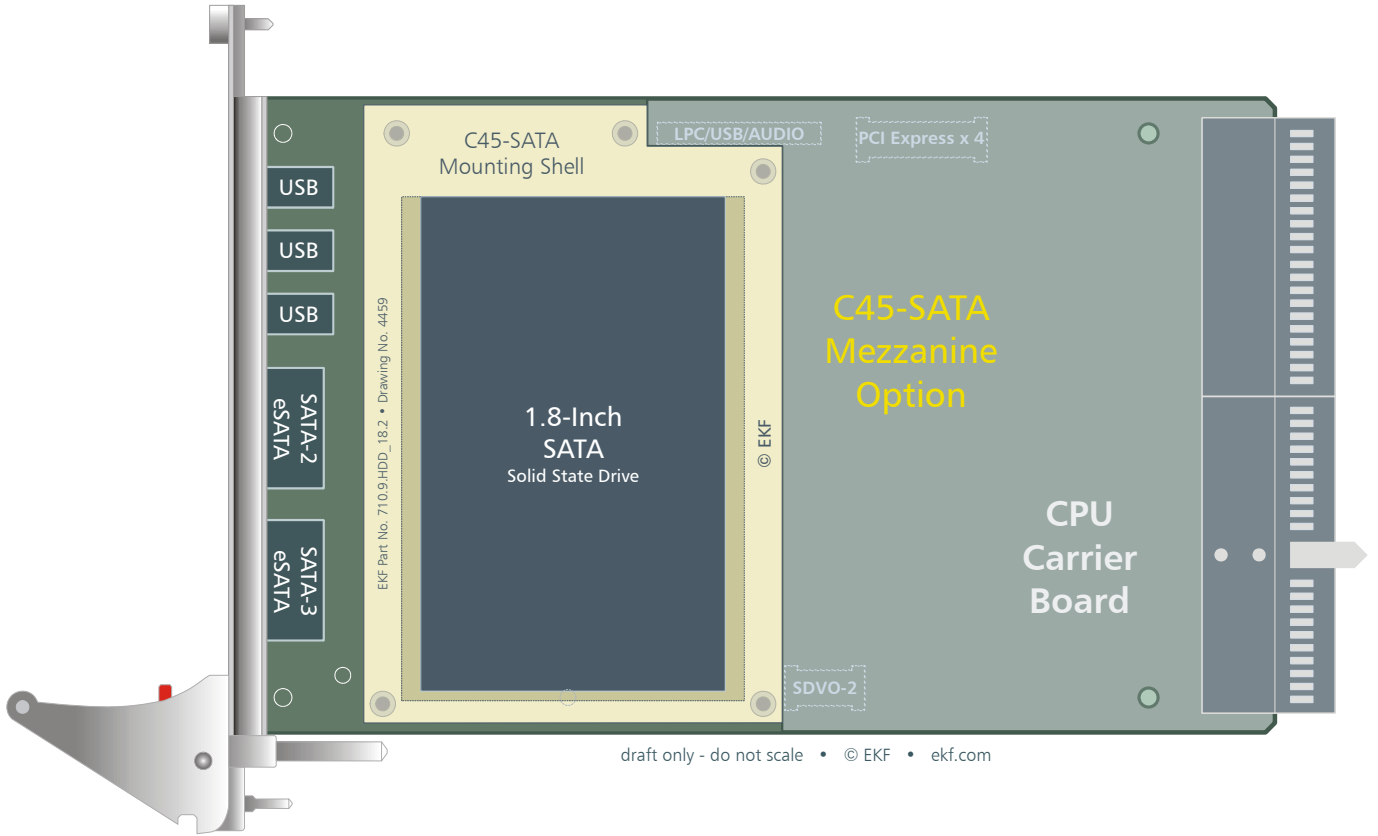



C45-SATA Top View



C45-SATA (Removable SSD) Top View

Front Panel

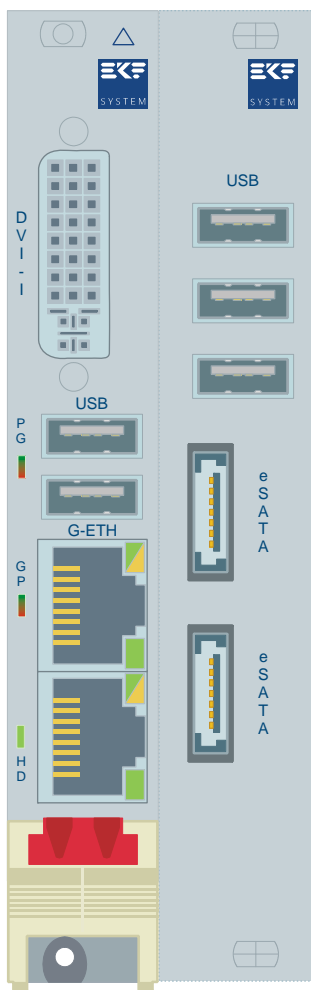

CCM-BOOGIE C45-SATA Internal SSD

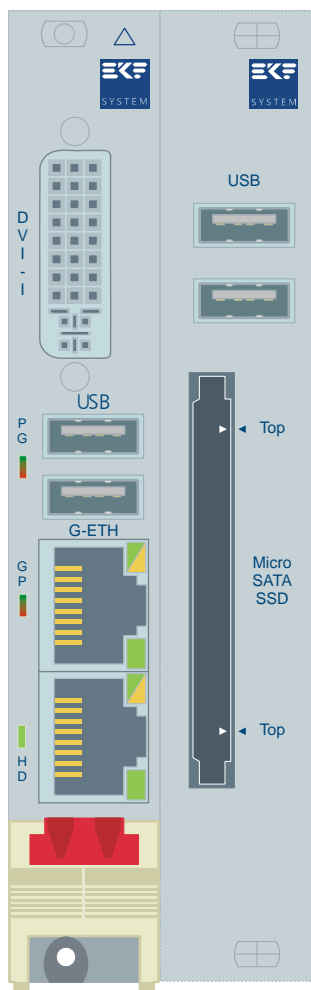

CCM-BOOGIE C45-SATA Removable SSD

draft only - do not scale • © EKF • ekf.com

Installing and Replacing Components

Before You Begin

Warnings

The procedures in this chapter assume familiarity with the general terminology associated with industrial electronics and with safety practices and regulatory compliance required for using and modifying electronic equipment. Disconnect any telecommunication links, networks or procedures described in this chapter. Failure links before you open the system or perform or equipment damage. Some parts of the the power switch is in its off state.



the system from its power source and from modems before performing any of the to disconnect power, or telecommunication any procedures can result in personal injury system can continue to operate even though

Caution

Electrostatic discharge (ESD) can damage components. Perform the procedures described in this chapter only at an ESD workstation. If such a some ESD protection by wearing an metal part of the system chassis or board original ESD protected packaging. Retain the antistatic box) in case of returning the board to EKF for repair.



station is not available, you can provide antistatic wrist strap and attaching it to a front panel. Store the board only in its original packaging (antistatic bag and

Installing the Board Assembly

Warning

This procedure should be done only by qualified technical personnel. Disconnect the system from its power source before doing the procedures described here. Failure to disconnect power, or telecommunication links before you open the system or perform any procedures can result in personal injury or equipment damage.

Typically you will perform the following steps:

- Switch off the system, remove the AC power cord
- Attach your antistatic wrist strap to a metallic part of the system
- Remove the board packaging, be sure to touch the board only at the front panel
- Identify the related CompactPCI slot (peripheral slot for I/O boards, system slot for CPU boards, with the system slot typically most right or most left to the backplane)
- Insert card carefully (be sure not to damage components mounted on the bottom side of the board by scratching neighbored front panels)
- A card with onboard connectors requires attachment of associated cabling now
- Lock the ejector lever, fix screws at the front panel (top/bottom)
- Retain original packaging in case of return



Removing the Board Assembly

Warning

This procedure should be done only by qualified technical personnel. Disconnect the system from its power source before doing the procedures described here. Failure to disconnect power, or telecommunication links before you open the system or perform any procedures can result in personal injury or equipment damage.

Typically you will perform the following steps:

- Switch off the system, remove the AC power cord
- Attach your antistatic wrist strap to a metallic part of the system
- Identify the board, be sure to touch the board only at the front panel
- unfasten both front panel screws (top/bottom), unlock the ejector lever
- Remove any onboard cabling assembly
- Activate the ejector lever
- Remove the card carefully (be sure not to damage components mounted on the bottom side of the board by scratching neighbored front panels)
- Store board in the original packaging, do not touch any components, hold the board at the front panel only



Warning

Do not expose the card to fire. Battery cells and other components could explode and cause personal injury.





EMC Recommendations

In order to comply with the CE regulations for EMC, it is mandatory to observe the following rules:

- The chassis or rack including other boards in use must comply entirely with CE
- Close all board slots not in use with a blind front panel
- Front panels must be fastened by built-in screws
- Cover any unused front panel mounted connector with a shielding cap
- External communications cable assemblies must be shielded (shield connected only at one end of the cable)
- Use ferrite beads for cabling wherever appropriate
- Some connectors may require additional isolating parts

Reccomended Accessories

| | | |
|-------------------------|--------------------------------------|--|
| Blind CPCI Front Panels | EKF Elektronik | Widths currently available (1HP=5.08mm): with handle 4HP/8HP without handle 2HP/4HP/8HP/10HP/12HP |
| Ferrit Bead Filters | ARP Datacom, 63115 Dietzenbach | Ordering No. 102 820 (cable diameter 6.5mm) 102 821 (cable diameter 10.0mm) 102 822 (cable diameter 13.0mm) |
| Metal Shielding Caps | Conec-Polytronic, 59557 Lippstadt | Ordering No. CDFA 09 165 X 13129 X (DB9) CDSFA 15 165 X 12979 X (DB15) CDSFA 25 165 X 12989 X (DB25) |

Technical Reference - Connectors

Caution

Some of the connectors may provide operating voltage (e.g. +12V, +5V and +3.3V) to devices inside the system chassis, such as internal peripherals. Not all of these connectors are overcurrent protected. Do not use these connectors for powering devices external to the computer chassis. A fault in the load presented by the external devices could cause damage to the board, the interconnecting cable and the external devices themselves.

Please Note

The C45-SATA mezzanine module may be equipped with several connectors for system internal and front panel (external) usage. Not all of these connectors may be present on a particular board. Be sure to specify your individual needs when ordering the C45-SATA board. Characteristic features and the pin assignments of each connector are described on the following pages.

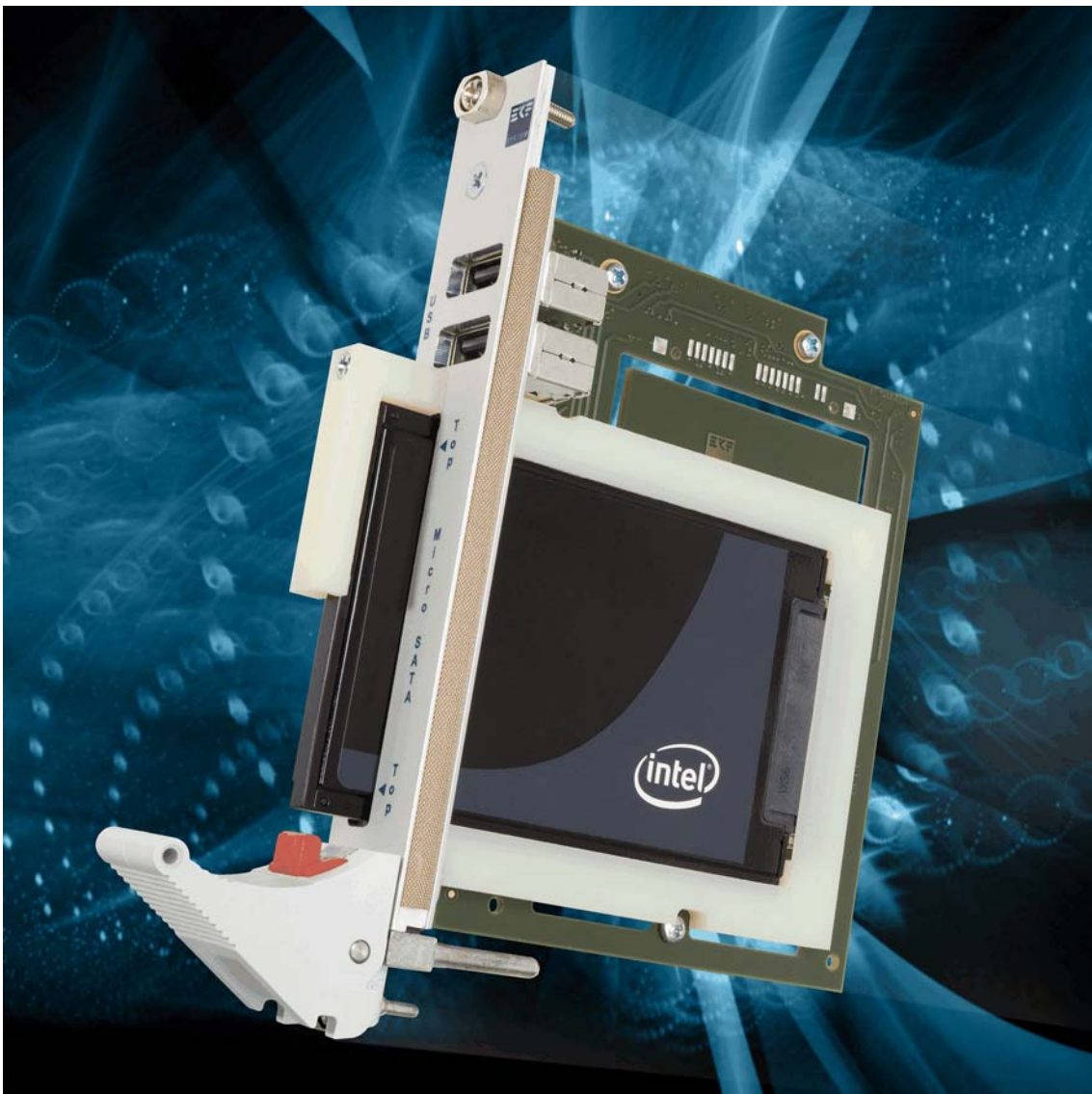

C45-SATA • Front Panel SSD Version

I/O Connectors

The C45-SATA is typically provided with several front panel I/O connectors, and an on-board Micro SATA docking header.

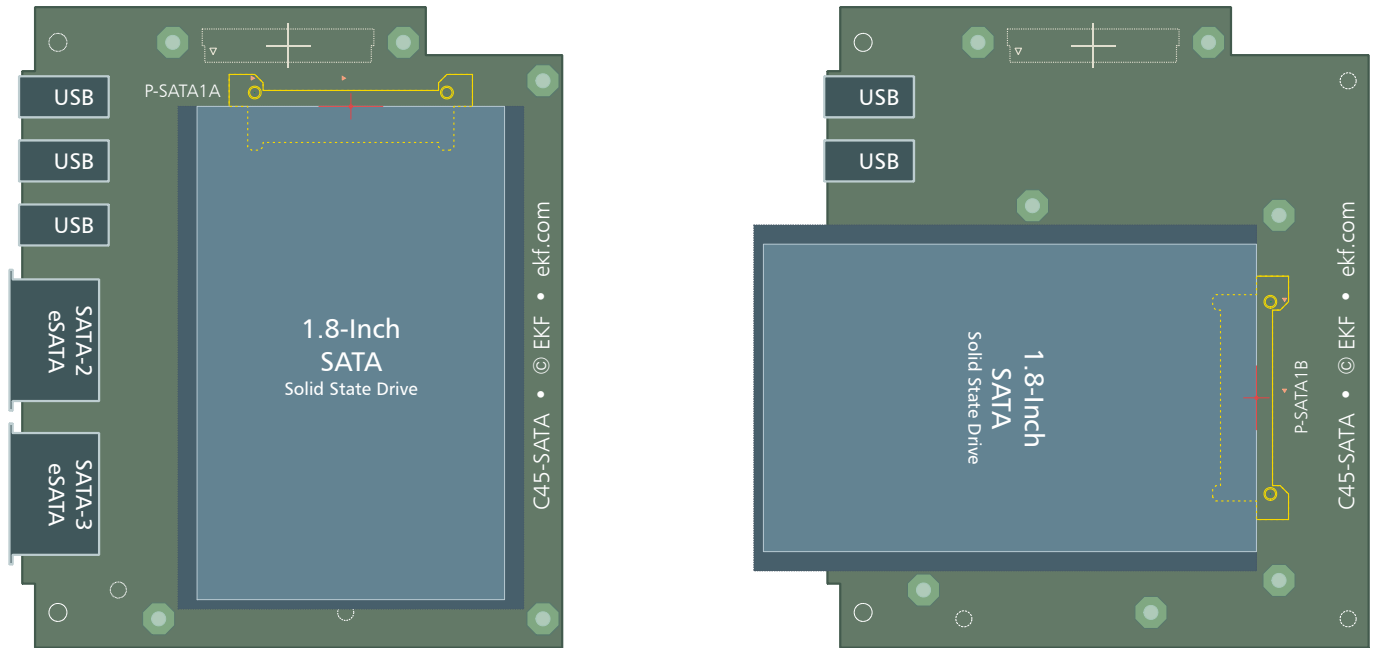

| I/O Connectors | |
|----------------|--|
| P-SATA1A | Micro SATA docking connector suitable for 1.8-inch internal on-board SATA drive - sourced from ICH/PCH Southbridge |
| P-SATA1B | Micro SATA docking connector suitable for 1.8-inch removable SATA drive - sourced from ICH/PCH Southbridge, alternate position - replaces P-SATA1A |
| SATA-2/SATA3 | eSATA front panel jacks suitable for external eSATA devices - derived from JMB362 RAID or non RAID |
| USB | Up to 3 x Type A front panel USB connectors for external USB equipment - ICH/PCH Southbridge |

P-SATA1A/B Micro SATA Docking Header

The C45-SATA can accommodate any 1.8-inch SATA standard form factor drive according to the SFF-8144 specification, which results in a 5.0 mm maximum height, and 78.5mm x 54.0mm dimensions. The Micro SATA connector in use is defined in Serial ATA Rev. 2.6. A Device with 8.0mm height (probably only hard disk) is not recommended for use on the C45-SATA, due to requirement for an alternate mounting assembly.

As an ordering option, the Micro SATA connector is positioned suitable either for an internal (fixed) mount solid state drive (P-SATA1A, or for a removable SSD (P-SATA1B), through the front panel. Please consider your application before ordering the C45-SATA. In either case, a mounting frame is used to hold the drive in its position, for extremely rugged applications.

P-SATA1A/B • Micro SATA Docking Connector 7+9 • 256.016.10.01



| | |
|----|----------------|
| S1 | GND |
| S2 | TX+ SATA1 |
| S3 | TX- SATA1 |
| S4 | GND |
| S5 | RX- SATA1 |
| S6 | RX+ SATA1 |
| S7 | GND |
| | |
| P1 | +3.3V |
| P2 | +3.3V |
| P3 | GND |
| P4 | GND |
| P5 | +5V |
| P6 | +5V |
| P7 | DAS (R to GND) |
| P8 | NC |
| P9 | NC |

Signal designations RX/TX assigned with respect to the SATA host controller (ICH Southbridge). Typical Micro SATA SSD devices are powered from a single +3.3V rail. Power is supplied (and switched on/off according to Sx state) from the CPU carrier board, across the C45-SATA mezzanine connector P-MEZ.

Note: Do not confuse the Micro SATA connector specified by Serial ATA Rev. 2.6 with the proprietary 'Special SATA' connector as defined by Samsung (refer to *Samsung 1.8" Form Factor Proposal*).



1.8-Inch Micro SATA Solid State Drive



Mounting Frame for Rugged Applications

SATA-2 SATA-3 eSATA F/P Connectors

The C45-SATA can be optionally equipped with two front panel eSATA signal headers. TX/RX designation of signals are shown with respect to the SATA controller JMB362 on the CPU carrier board. Shielded external eSATA cable assemblies are recommended for reliable industrial usage.

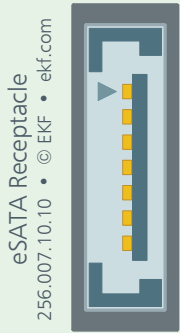
| 2 x F/P eSATA #256.007.10.10 Receptacles | | |
|---|---|----------|
|  | 1 | GND |
| | 2 | SATA_TX+ |
| | 3 | SATA_TX- |
| | 4 | GND |
| | 5 | SATA_RX- |
| | 6 | SATA_RX+ |
| | 7 | GND |

Remember that SATA is a high speed data link - the typical external cable length should not exceed 2m. Chose the minimum distance possible for locating the external SATA device, and use high quality cable assemblies for reliable industrial operation, such as the Molex 68782 series (EKF part no. 256.007.82.10 and 256.007.82.20). For experimental purposes, there are also adapter cable assemblies available from eSATA to SATA (EKF part no. 256.007.81.10).

Compared to internal SATA cabling, the eSATA front panel connectors offer superior shielding and provide EMI protection. eSATA connectors and cable harnesses used or supplied by EKF adhere to the design specifications recommended by the Serial ATA International Organization (SATA-IO).

With a CCM-BOOGIE CPU carrier board, JMicron JMB36 drivers must be installed before using the front panel connectors, either RAID drivers or non-RAID drivers: <ftp://driver.jmicron.com.tw/jmb36x/>

The eSATA front panel connectors are not available together with the removable SSD option.

USB F/P Receptacles

The host CPU board is equipped with an ICHx (Input/Output Controller Hub), which incorporates a number of USB 1.1/2.0 compliant ports. Several of the USB interfaces are passed to the C45-SATA through the inter-board connector P-MEZ, ending up in the front panel USB connectors. Overcurrent protection is provided by electronic switches individually for each USB receptacle.

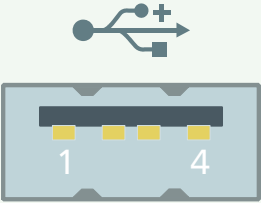
| 3 x USB Receptacle 270.20.04.1 | | |
|---|---|-----------------|
|  <p>USB Receptacle © EKF • ekf.com 270.20.04.1</p> | 1 | +5V_USB 0.5A 1) |
| | 2 | DATA- |
| | 3 | DATA+ |
| | 4 | GND |

1) Electronic Power Switch

If the removable solid state drive option was chosen for the C45-SATA, only two USB front panel connectors are provided.

Inter-Board Connector

The C45-SATA is equipped with a high speed mezzanine connector P-MEZ, mating with the CCM-BOOGIE CPU carrier board and its successors. The inter-board connector is situated at the bottom of the C45-SATA and establishes the data path and power link to the carrier board J-HSE. Since the C45-SATA comes typically mounted as a unit together with the CPU carrier board, there is normally no need for the user to get access to the inter-board connector. It is described here as a reference only and for better understanding of the C45-SATA

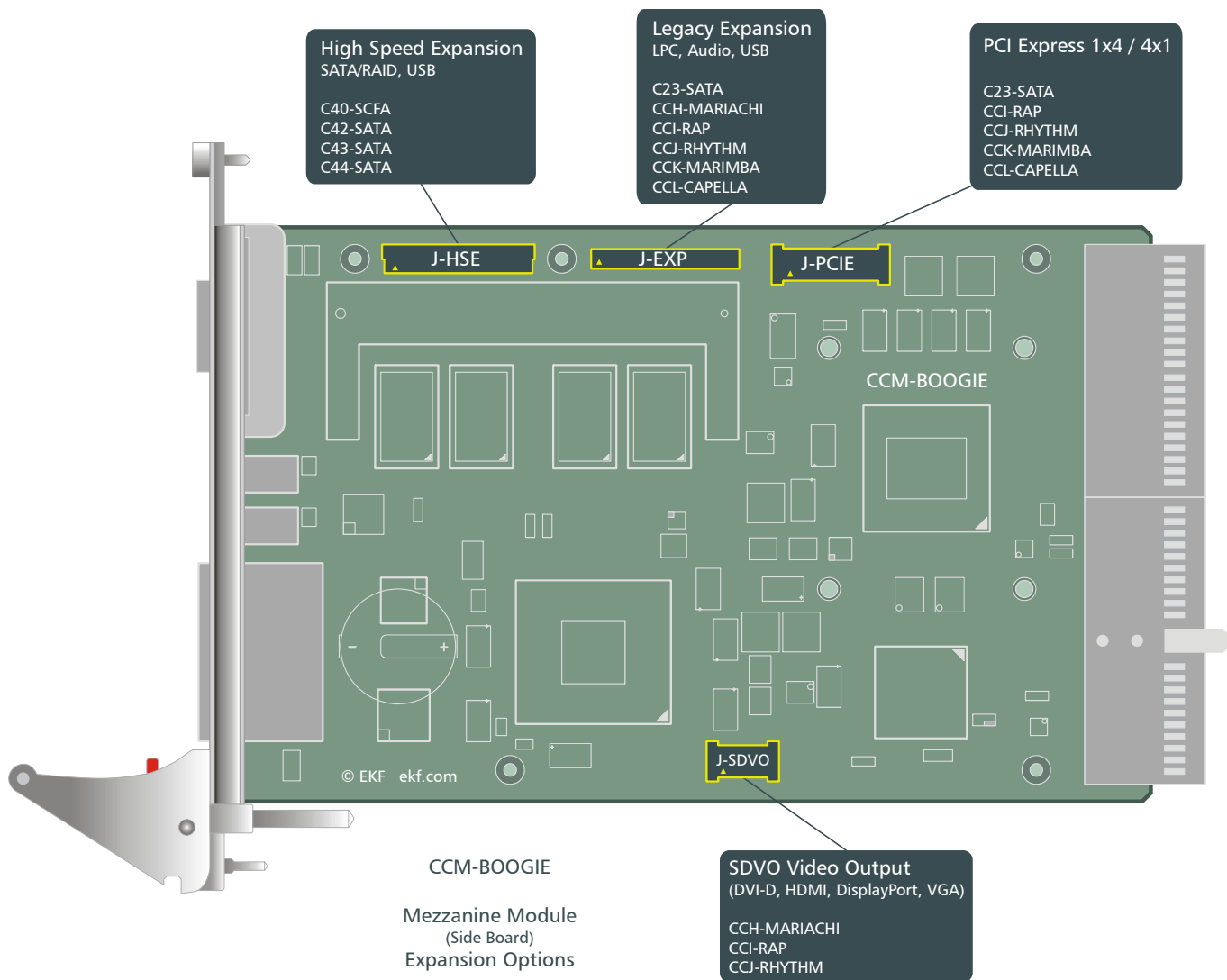

P-MEZ

The connector P-MEZ is a 10mm nominal height shielded male pin header. Its counterpart on the CPU carrier board is a 8mm height receptacle (J-HSE), for a nominal headroom of 18.72mm between the two boards (which is equivalent to 4HP=20.32mm board to board CL).

| P-MEZ • SATA & USB Mezzanine Interface 1.00mm Pitch Male Connector 10mm Height (275.90.10.068.51) | | | | |
|--|--------------|-----|-----|--------------|
| | GND | b1 | a1 | GND |
| | SATA3_TXP 4) | b2 | a2 | SATA1_TXP 3) |
| | SATA3_TXN 4) | b3 | a3 | SATA1_TXN 3) |
| | GND | b4 | a4 | GND |
| | SATA3_RXN 4) | b5 | a5 | SATA1_RXN 3) |
| | SATA3_RXP 4) | b6 | a6 | SATA1_RXP 3) |
| | GND | b7 | a7 | GND |
| | SATA4_TXP | b8 | a8 | SATA2_TXP 4) |
| | SATA4_TXN | b9 | a9 | SATA2_TXN 4) |
| | GND | b10 | a10 | GND |
| | SATA4_RXN | b11 | a11 | SATA2_RXN 4) |
| | SATA4_RXP | b12 | a12 | SATA2_RXP 4) |
| | GND | b13 | a13 | GND |
| | USB3_P | b14 | a14 | USB1_P |
| | USB3_N | b15 | a15 | USB1_N |
| | GND | b16 | a16 | GND |
| | USB4_P | b17 | a17 | USB2_P |
| | USB4_N | b18 | a18 | USB2_N |
| | GND | b19 | a19 | GND |
| | USB3_OC# | b20 | a20 | USB1_OC# |
| | USB4_OC# | b21 | a21 | USB2_OC# |
| | +5VS 2) | b22 | a22 | +3.3VS 1) |
| | +5VS 2) | b23 | a23 | +3.3VS 1) |
| | +5VA | b24 | a24 | +3.3VA |
| | RSVD | b25 | a25 | +12VA |

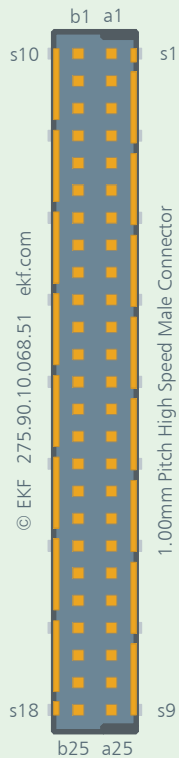

- 1) 2) Switched voltages from carrier board, according to CPU sleep state S0
- 3) This SATA channel has been derived from ICH/PCH southbridge
- 4) These SATA channels are derived from the additional secondary PCIe SATA controller, RAID 0/1/10 capable

Notes:

- ▶ All s# connector pins (shield) are tied to GND
- ▶ All TX/RX designations with respect to SATA controller (TX controller = RX drive, RX controller = TX drive)



C45-SATA Bottom View



C45-SATA Bottom View (Front Panel SSD)



C45-SATA • PC1-GROOVE

Schematics

Complete circuit diagrams for this product are available for customers on request. Signing of a non-disclosure agreement would be needed. Please contact sales@ekf.de for details.

EKF reserves the right to refuse distribution of confidential information material for any reason that EKF may consider substantial.

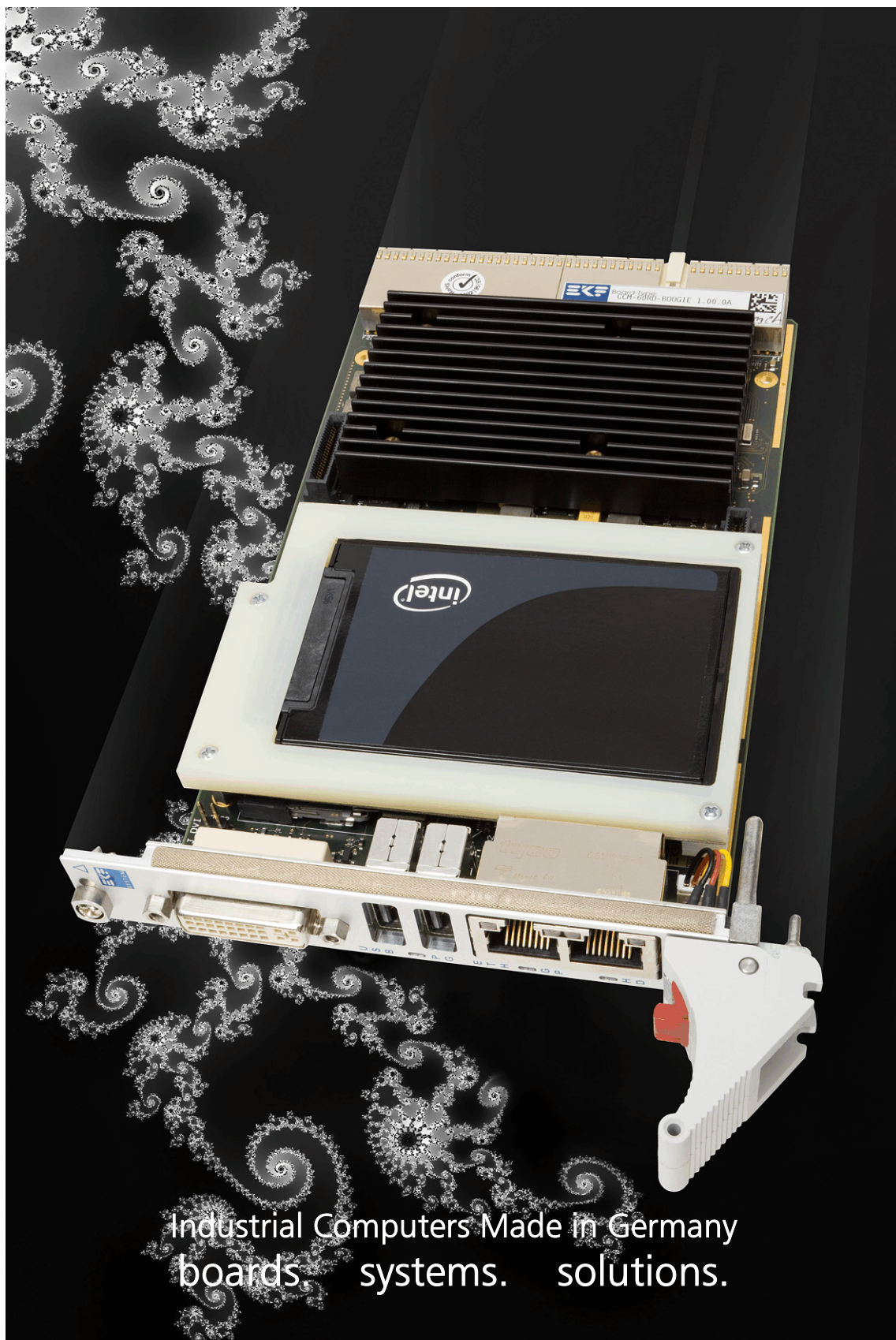

Industrial Computers Made in Germany
boards. systems. solutions.

EKF Elektronik GmbH
Philipp-Reis-Str. 4
59065 Hamm
Germany



Phone +49 (0)2381/6890-0
Fax +49 (0)2381/6890-90
Internet www.ekf.com
E-Mail info@ekf.com